

A close-up photograph of white and pink Ergoline equipment components. The word "Ergoline" is written in red cursive on a white surface. The background is dark blue.

PRICELIST 02/2018

EQUIPMENT & PRICES

ERGOLINE

SUN ANGEL

BEAUTY ANGEL

Ergoline

TOPSELLER SYSTEM

Dear customer,

Thank you for your interest in our brands. In this price list we offer you equipment in different price ranges, designs and features. In order to help you select your favorite product we have marked "Topseller" equipment in this price list. Topseller are first choice of our customers.

Practical features, high acceptance of customers, best value for money combined with highest resale value distinguishes our products. Topseller versions we generally deliver 2-4 weeks after we receive your order.

Of course we are also happy if you buy a „non Topseller“ version. We are also very happy to produce these units individually for you! Please note, that when you order a “non Topseller” version a 10% prepayment of the list price is due. The delivery time of these products is approx. 4 weeks.

Topseller or not – the entire JK-Team wishes you lots of success with your new equipment.

JK PROFESSIONAL PRICELIST 02/2018

This price list takes effect from 1st February 2018. It will retain validity until a new price list is published. The products offered in this price list are exclusively distributed by JK-International GmbH and their trade partners. The prices quoted are list prices and exclude statutory VAT.

The products indicated in this price list are delivered ex works. Changes in the technical execution and design, price and delivery possibility reserved. All prices for our equipment are excluded time control system.

The products listed must not be exported to or operated in either the USA and Canada JK-International GmbH shall not accept any producer's liability in this case. It is expressly pointed out that any violation of this ban may subject the exporter and/or operator to high risks of liability.

You may obtain all expendable articles, such as bulbs, lamps, starters, Aqua Fresh & Aroma refit kits as well as cleaning and cosmetic products from JK-International GmbH, Koehlershohner Strasse, 53578 Windhagen, Germany, phone +49 2224/818-600.

WARRANTY

JK-International GmbH guarantees the purchaser for a period of 24 months starting from the date of delivery that the goods are free from defects which would ruin or reduce their value or usual merchantability. High-pressure lamps, low-pressure lamps and starters as well as base acrylics are components that are subject to a process of natural wear. Defect-related claims on part of the purchaser shall be ruled out if the product defect is the result of wear.

QUALITY PAYS – 10 GOOD REASONS FOR ERGOLINE

When dealing with the sun quality is paying off. The factors of success can be easily combined: Excellent products, excellent service, an excellent business concept and especially well-known brand names. Ergoline gives you that competitive edge. But don't take our word for it, compare Ergoline with the rest; you don't want to settle for less.

EXCELLENT BRAND NAME

Ergoline is by far the world's most popular sunbed brand name amongst salon owners and customers alike. There are good reasons for that. Deciding for a professional sunbed from the worldwide market leader means setting the scenes for success in the tanning business. You benefit not only from our product's reliability and long service life in the endurance test that is everyday salon operation, but also the low depreciation on all our models when it comes to selling your used Ergoline sunbed.

APPROVED SAFETY

Ergoline keeps you on the safe side. Our models carry the German TÜV seal and GS "tested safety" kitemark, and naturally the statutory CE label. All components that need to be accessible for maintenance and servicing are easy to reach, and are equipped with multiple backup safety features with an intelligent protection system, switching off automatically if a malfunction is detected.

GUARANTEED QUALITY

All components we use in our sunbed production are made of high-quality materials, which are all tested for resistance against UV light, cleaning fluids and other potential hazards as well as potential health risks. Our state-of-the-art manufacturing technologies and

qualified staff ensure especially high-quality workmanship. Every Ergoline sunbed undergoes a variety of functional tests before it leaves the factory. We were the first sunbed manufacturer to be certified by TÜV for compliance with the EN ISO 9001 quality standard, confirming our claim to quality.

EXCELLENT SERVICE

If you should experience technical problems with one of your Ergoline sunbeds, we have a complete service network to fix the problem. We guarantee prompt and professional repairs by authorised and qualified service technicians. Our technicians carry a wide range of commonly used spare parts. As an added support, thousands of parts are stored at our state-of-the-art logistics centre.

TRENDSETTING DESIGN

Often, you'll only really appreciate excellent design after years of use. This is why you will not find any superficial trends or gimmicks on our sunbeds. Clear lines, quality surface finishes and fascinating lighting effects will inspire your customers now and in years to come. Furthermore, the LED Light Show provides a fascinating light presentation and many individualisation possibilities. Make your daily studio routine more colourful!

COMFORT SECOND TO NONE

Our ergonomic concepts give you and your customers tanning comfort and convenience that is second to none. Or Climatronic cooled air conditioning for exact tanning temperature adjustment. Aqua Fresh & Aroma will give your customers a particularly refreshing tanning experience. Innovative 3D sound systems give you perfect musical enjoyment.

EASY HANDLING

Every Ergoline sunbed has been designed to ensure that all components that require servicing are easily and quickly to reach. Low-maintenance materials ensure easy cleaning for your salon staff. The Professional Set-up Manager provides an extraordinary sunbed management. Whether you choose the light program, sound settings or adjust air condition and ventilation – all settings perform easier and faster than ever. With the NFC Connect you can transfer the entire configuration to other sunbeds.

INNOVATIVE UV TECHNOLOGIES

Ergoline's innovative UV systems lead the world. The company's in-house Development Centre has regularly launched new cutting-edge technologies to increase tanning power, energy efficiency, and naturally also safety in sunbeds. Our Hybrid Performance technology sets new standards in tanning technology. This unique combination of UV and red light delivers a particularly attractive and long-lasting tan with simultaneous skin care. Another totally new feature is Personal Sunstyle. Every customer can have their personally select their tan at the touch of a button. The maximum output of lamps and facials is adapted to the national regulations.

EXCELLENT SUPPORT FOR YOUR SALON

Ergoline has set standards in professionalising the tanning business with regular training programmes and courses. We also provide high-profile advertising and Point of Sale sales support with high-impact marketing concepts, numerous videos and attractive campaign materials.

PROFESSIONAL SUNBEDS HYBRID UNITS BEAUTY ANGEL

AIR DISCHARGE SYSTEM
ACCESSORIES

CONTROL SYSTEMS
STUDIO EQUIPMENT

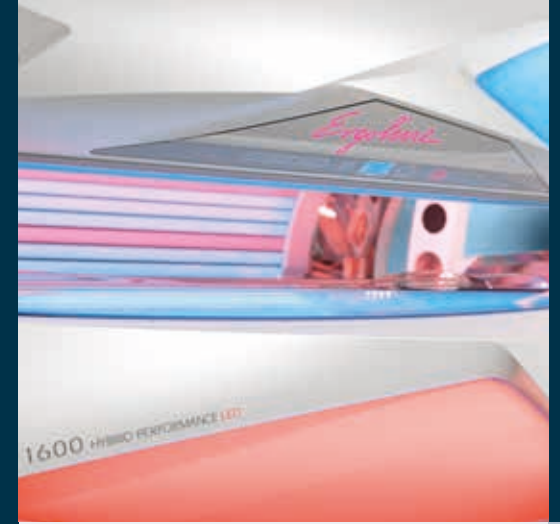

ERGOLINE PRESTIGE 1600 HYBRID PERFORMANCE LED

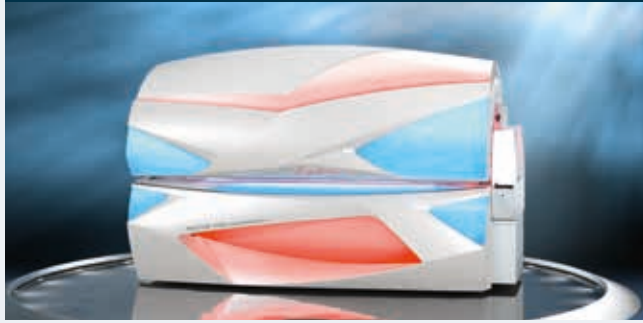

FEATURED AS STANDARD

- Hybrid Performance LED
- Beauty Light LED
- Ultra Performance PLUS
- Shoulder Tan HP
- LED Light Show
- Interior Light
- Personal Sunstyle
- Control Center
- NFC Connect
- Smart Control
- Set-up Manager
- Voice Guide
- Service Light
- Bluetooth
- Aqua Fresh
- Aroma
- Climatronic
- 3D Sound
- MP3 Aux
- ECO Tech
- Multi Relax



DIMENSIONS (in mm)

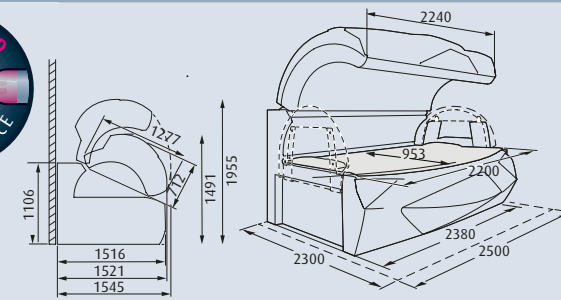

UV	WATTS MAX.	smartsun PLUS	WATTS MAX.	FT	WATTS MAX.
38	200	14	200	4	520

DESIGN SILVERPEARL

	Art. No. EN	Euro, excl. VAT.
Featured as standard	500001281	45,595.-
Featured as standard incl. Climatronic PLUS	500001282	46,695.-



Featured as standard

Lamps: 24 top part/8 side part/20 base part | The power of the facials might be reduced to 420 W due to national regulations (0.3 W/m²).

* 3D-Sound unit includes Voice Guide, MP3- & iPod-Dock-in, SD-Card-Slot Automatic Volume and Auto Play.

ERGOLINE PRESTIGE 1400

INTELLIGENT PERFORMANCE

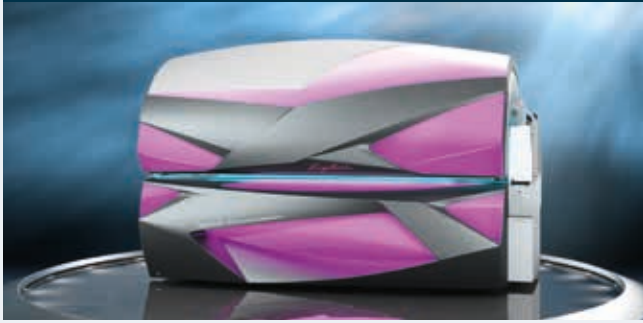

FEATURED AS STANDARD

- Intelligent Performance
- Ultra Performance PLUS
- Shoulder Tan HP
- LED Light Show
- Interior Light
- Multi Relax
- Climatronic PLUS (closed tanning tunnel)
- Comfort Cooling PLUS
- Aqua Fresh
- Aroma
- 3D-Sound-Unit
- MP3 Aux
- Voice Guide
- ECO Tech
- Control Center
- NFC Connect
- Set-up Manager
- Bluetooth
- Service Light



LAMPS	WATTS MAX.	FT	WATTS MAX.	FT SPAGHETTIS
52	200	4	520	3 x 8 W

DIMENSIONS (in mm)

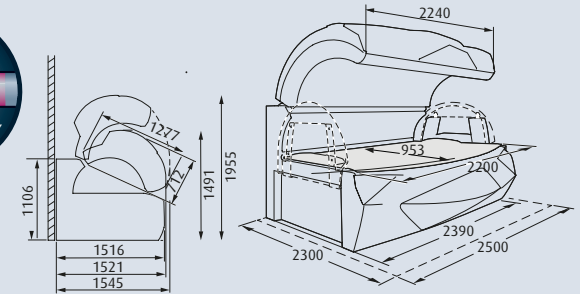

DESIGN CARBON GREY

Art. No. EN

Euro, excl. VAT.

Featured as standard incl. Climatronic PLUS • Aqua Fresh & Aroma • Shoulder Tan HP incl. 3D-Sound-Unit*

500001285



44,095.-

Featured as standard

INTELLIGENT PERFORMANCE 52 x 200 W	ULTRA PERFORMANCE + 4 x 520 W 3 x 8 W	2 x 240 W SHOULDER TAN	LED LIGHT SHOW	INTERIOR LIGHT	220 x 95 CM MULTI RELAX	COMFORT COOLING +	CLIMATRONIC PLUS	AQUA FRESH	AROMA
3D SOUND	MP3 AUX	VOICE GUIDE	ECO TECH	CONTROL CENTER	NFC CONNECT	SET-UP MANAGER	BLUETOOTH CONNECT	SERVICE LIGHT	

Lamps: 24 top part/8 side part/20 base part | The power of the facials might be reduced to 420 W due to national regulations (0.3 W/m²).

* 3D-Sound unit includes Voice Guide, MP3- & iPod-Dock-in, SD-Card-Slot Automatic Volume and Auto Play.

ERGOLINE PRESTIGE 1200

INTELLIGENT PERFORMANCE

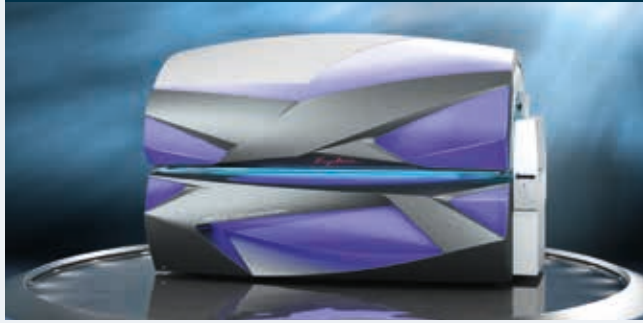

FEATURED AS STANDARD

- Intelligent Performance
- Ultra Performance PLUS
- LED Light Show
- Interior Light
- Multi Relax
- Comfort Cooling PLUS
- Climatronic
- ECO Tech
- Control Center
- NFC Connect
- Set-up Manager
- Service Light



DIMENSIONS (in mm)

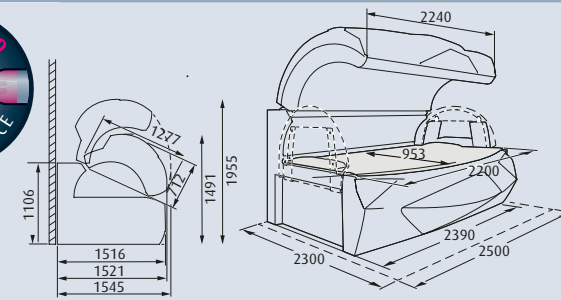

LAMPS	WATTS MAX.	FT	WATTS MAX.	FT SPAGHETTIS
52	200	4	520	3 x 8 W

DESIGN CARBON GREY

Art. No. EN

100003395

Euro, excl. VAT.

**TOP
SELLER**

38,895.-

Featured as standard incl. Climatronic

Optional extra: Shoulder Tan HP incl. 3D-Sound-Unit* and Bluetooth Connect

100003382

3,095.-

Featured as standard

INTELLIGENT 52 x 200 W PERFORMANCE	ULTRA 4 x 520 W 3 x 8 W PERFORMANCE +	LED LIGHT SHOW	INTERIOR LIGHT	220 x 95 CM MULTI RELAX	COMFORT COOLING +
CLIMATRONIC	ECO TECH	CONTROL CENTER	NFC CONNECT	SET-UP MANAGER	SERVICE LIGHT

Optional at extra costs

2 x 240 W SHOULDER TAN	3D SOUND	BLUETOOTH CONNECT
MP3 AUX	VOICE GUIDE	

Lamps: 24 top part/8 side part/20 base part | The power of the facials might be reduced to 420 W due to national regulations (0.3 W/m²).

* 3D-Sound unit includes Voice Guide, MP3- & iPod-Dock-in, SD-Card-Slot Automatic Volume and Auto Play.

ERGO LINE PRESTIGE 1000

INTELLIGENT PERFORMANCE



FEATURED AS STANDARD

- Intelligent Performance
- Ultra Performance PLUS
- LED Light Show
- Interior Light
- Multi Relax
- Comfort Cooling PLUS
- Climatronic
- ECO Tech
- Control Center
- NFC Connect
- Set-up Manager
- Service Light

Optional

- Aqua Fresh
- Aroma



DIMENSIONS (in mm)

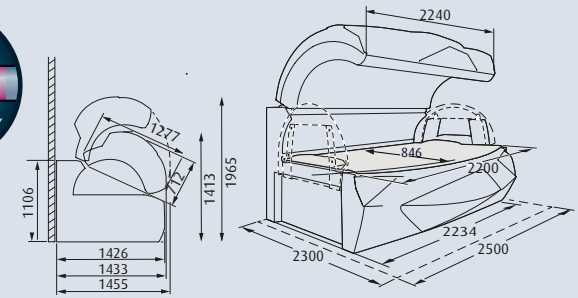

LAMPS	WATTS MAX.	FT	WATTS MAX.	FT SPAGHETTIS
48	200	4	500	3 x 8 W

DESIGN DIAMANT SILVER

Art. No. EN

Euro, excl. VAT.

Featured as standard incl. Climatronic • incl. NFC

100003407

38,295.-

Featured as standard incl. Climatronic • incl. NFC • incl. Aqua Fresh & Aroma

500001292

TOP
SELLER

39,395.-

Optional extra: Shoulder Tan HP incl. 3D-Sound-Unit* and Bluetooth Connect

100003382

3,095.-

Featured as standard

INTELLIGENT 48 x 200 W PERFORMANCE	ULTRA 4 x 500 W 3 x 8 W PERFORMANCE +	LED LIGHT SHOW	INTERIOR LIGHT	220 x 85 CM MULTI RELAX	COMFORT COOLING +	CLIMATRONIC
AQUA FRESH	AROMA	ECO TECH	CONTROL CENTER	NFC CONNECT	SET-UP MANAGER	SERVICE LIGHT

Optional at extra costs

2 x 240 W SHOULDER TAN	3D SOUND	BLUETOOTH CONNECT
MP3 AUX	VOICE GUIDE	

Lamps: 22 top part/8 side part/18 base part | The power of the facials might be reduced to 420 W due to national regulations (0.3 W/m²).

* 3D-Sound unit includes Voice Guide, MP3- & iPod-Dock-in, SD-Card-Slot Automatic Volume and Auto Play.

ERGO LINE AFFINITY 990 SLP HYBRID PERFORMANCE



FEATURED AS STANDARD

- Hybrid Performance
- Smart Light Performance
- LED Light Show
- Interior Light
- Smart Control
- Body Shape
- Comfort Cooling PLUS
- Air Condition PLUS

Optional

- Aqua Fresh
- Aroma



DIMENSIONS (in mm)

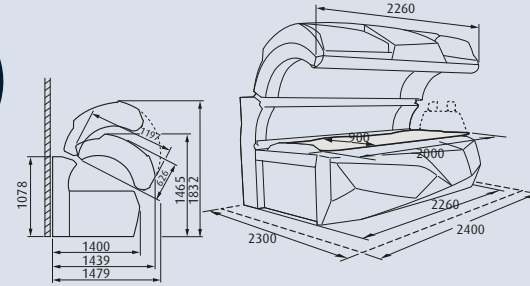

LAMPS	WATTS MAX.	FT	WATTS MAX.	FT SPAGHETTIS
50	180	4	420	3 x 8 W

DESIGN BRILLIANT WHITE

	Artikel-Nr. EN	Euro ohne MwSt.
Featured as standard incl. Air Condition PLUS, dimmable electronic ballasts	100003448	33,595.-
Featured as standard incl. Air Condition PLUS, dimmable electronic ballasts • incl. Aqua Fresh & Aroma	500001327	34,595.-
Optional extra: 3D-Sound-Unit**	100000852	1,035.-
Optional extra: smartsun Shoulder Tan incl. 3D-Sound-Unit**	100003450	2,275.-



Featured as standard

HYBRID 16x 180 W 34x 180 W PERFORMANCE	SMART LIGHT PERFORMANCE	LED LIGHT SHOW	INTERIOR LIGHT	SMART CONTROL
BODY SHAPE	COMFORT COOLING +	AIR CONDITION +	AQUA FRESH	AROMA

Optional at extra costs

SMARTSUN 7x 25 W SHOULDER TAN	3D SOUND
MP3 AUX	VOICE GUIDE

Lampes: 24 top part/8 side part/18 base part | The power of the facials might be reduced to 420 W due to national regulations (0.3 W/m²).

* You receive two additional sets of lamps with low-pressure UV lamps and high-pressure facials incl. spaghetti lamps.

** 3D-Sound unit includes Voice Guide, MP3- & iPod-Dock-in, SD-Card-Slot Automatic Volume and Auto Play.

ERGO LINE AFFINITY 990

DYNAMIC PERFORMANCE

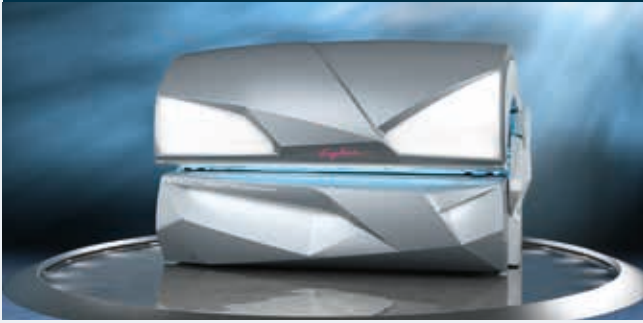

FEATURED AS STANDARD

- Dynamic Performance
- Ultra Performance PLUS
- LED Light Show
- Interior Light
- Smart Control
- Body Shape
- Comfort Cooling PLUS
- Air Condition PLUS

Optional

- Aqua Fresh
- Aroma



LAMPS	WATTS MAX.	FT	WATTS MAX.	FT SPAGHETTIS
50	180	4	520	3 x 8 W

DIMENSIONS (in mm)

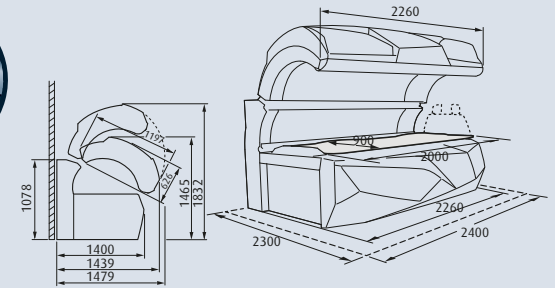

DESIGN PLATINUM GREY

	Art. No. EN	Euro, excl. VAT.
Featured as standard incl. Air Condition PLUS	100003281	32,595.-
Featured as standard incl. Air Condition PLUS • incl. Aqua Fresh & Aroma	500001211	33,595.-
Optional extra: Shoulder Tan	100003297	1,200.-
Optional extra: 3D-Sound-Unit**	100000852	1,035.-
Optional extra: Shoulder Tan inkl. 3D-Sound-Unit**	100003298	2,275.-



Featured as standard

DYNAMIC 50 x 180 W PERFORMANCE	ULTRA 4 x 520 W 3 x 8 W PERFORMANCE +	LED LIGHT SHOW	INTERIOR LIGHT	SMART CONTROL
208 x 90 CM BODY SHAPE	COMFORT COOLING +	AIR CONDITION +	AQUA FRESH	AROMA

Optional at extra costs

7 x 25 W SHOULDER TAN	3D SOUND	MP3 AUX
VOICE GUIDE		

Lamps: 24 top part/8 side part/18 base part | The power of the facials might be reduced to 420 W due to national regulations (0.3 W/m²).

* You receive two additional sets of lamps with low-pressure UV lamps and high-pressure facials incl. spaghetti lamps.
** 3D-Sound unit includes Voice Guide, MP3- & iPod-Dock-in, SD-Card-Slot Automatic Volume and Auto Play.

ERGO LINE AFFINITY 900 ADVANCED PERFORMANCE

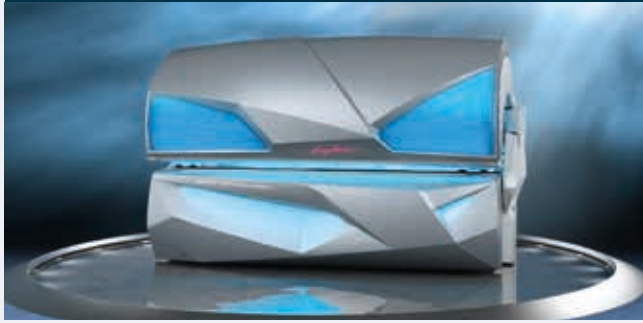

FEATURED AS STANDARD

- Advanced Performance
- Ultra Performance PLUS
- LED Light Show
- Interior Light
- Smart Control
- Body Shape
- Comfort Cooling PLUS
- Air Condition PLUS



LAMPS	WATTS MAX.	FT	WATTS MAX.	FT SPAGHETTIS
50	160	4	520	3 x 8 W

DIMENSIONS (in mm)

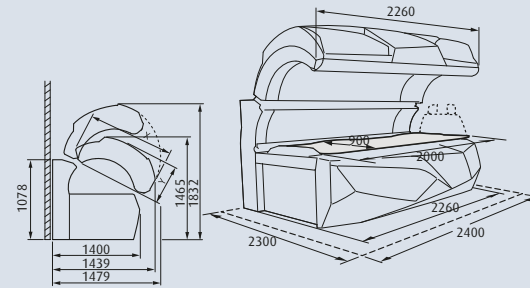

DESIGN PLATINUM GREY

Featured as standard Turbo Power incl. Air Condition PLUS



Art. No. EN

100003265



Euro, excl. VAT.

28,575.-

Optional extra: Shoulder Tan	100003297	1,200.-
Optional extra: 3D-Sound-Unit**	100000852	1,035.-
Optional extra: Shoulder Tan inkl. 3D-Sound-Unit**	100003298	2,275.-

Featured as standard

ADVANCED TURBO POWER 50 x 160 W PERFORMANCE	ULTRA 4 x 520 W 3 x 8 W PERFORMANCE +	LED LIGHT SHOW	INTERIOR LIGHT
SMART CONTROL	208 x 90 CM BODY SHAPE	COMFORT COOLING +	AIR CONDITION +

Optional at extra costs

7 x 25 W SHOULDER TAN	3D SOUND	MP3 AUX
VOICE GUIDE		

Lamps: 24 top part/8 side part/18 base part | The power of the facials might be reduced to 420 W due to national regulations (0.3 W/m²).

* You receive two additional sets of lamps with low-pressure UV lamps and high-pressure facials incl. spaghetti lamps.

** 3D-Sound unit includes Voice Guide, MP3- & iPod-Dock-in, SD-Card-Slot Automatic Volume and Auto Play.

ERGO LINE AFFINITY 700 ADVANCED PERFORMANCE

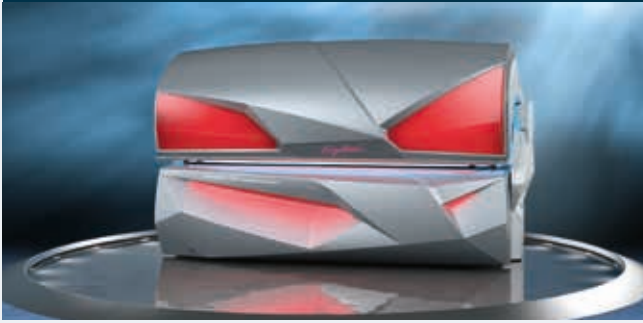

FEATURED AS STANDARD

- Advanced Performance
- Ultra Performance PLUS
- LED Light Show
- Interior Light
- Smart Control
- Body Shape
- Comfort Cooling PLUS

- Optional**
- Air Condition PLUS (only Turbo Power)



LAMPS	WATTS MAX.	FT	WATTS MAX.	FT SPAGHETTIS
46	160	3	500	2x 8 W

DIMENSIONS (in mm)

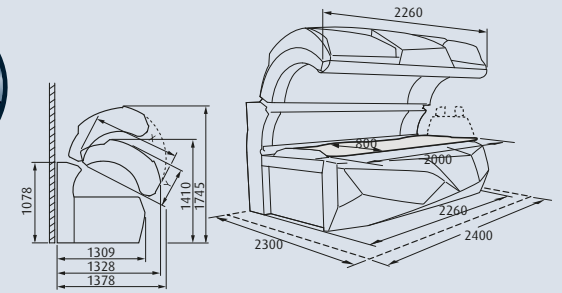

DESIGN PLATINUM GREY

	Art. No. EN	Euro, excl. VAT.
Featured as standard Twin Power (28 Lamps à 160 W / 18 Lamps à 120 W)	100003266	21,995.-
Featured as standard Twin Power (28 Lamps à 160 W / 18 Lamps à 120 W), incl. intermediate acrylic	100003335	22,675.-
Featured as standard Turbo Power incl. Air Condition PLUS (46 Lamps à 160 W)	100003322	26,195.-
Optional extra: Shoulder Tan	100003297	1,200.-
Optional extra: 3D-Sound-Unit**	100000852	1,035.-
Optional extra: Shoulder Tan inkl. 3D-Sound-Unit**	100003298	2,275.-



Featured as standard

ADVANCED

TWIN POWER

28 x 160 W
18 x 120 W

PERFORMANCE

ADVANCED

TURBO POWER

46 x 160 W

PERFORMANCE

ULTRA

3x 500 W
2x 8 W

PERFORMANCE +

LED LIGHT SHOW

INTERIOR LIGHT

SMART CONTROL

208 x 80 CM

BODY SHAPE

COMFORT COOLING +

AIR CONDITION +

Optional at extra costs

7 x 25 W

SHOULDER TAN

3D SOUND

MP3 AUX

VOICE GUIDE

Lamps: 20 top part/8 side part/18 base part | The power of the facials might be reduced to 420 W due to national regulations (0.3 W/m²).

* You receive two additional sets of lamps with low-pressure UV lamps and high-pressure facials incl. spaghetti lamps.

** 3D-Sound unit includes Voice Guide, MP3- & iPod-Dock-in, SD-Card-Slot Automatic Volume and Auto Play.

ERGOLINE INSPIRATION 600

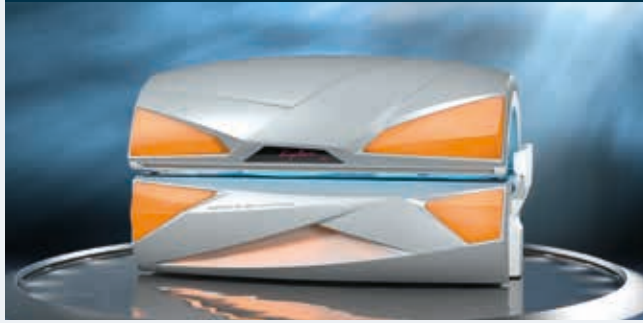

FEATURED AS STANDARD

- Ultra Performance PLUS
- LED Light Show
- Interior Light
- Bodyform PLUS
- Comfort Cooling PLUS
- NFC Connect

Optional

- Air Condition PLUS
- Aqua Fresh
- Aroma



DIMENSIONS (in mm)

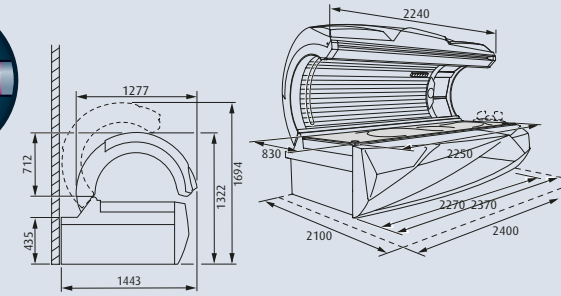

LAMPEN	GB	WATT MAX.	GB SPAGHETTIS
42	4	400	3 x 8 W

DESIGN SATIN SILVER

	Art. No. EN	Euro, excl. VAT.
Featured as standard Smart Performance, Twin Power [26 Lampen à 140 (160) W/16 Lampen à 120 (140) W]* incl. NFC	100003169	20,995.-
Featured as standard Dynamic Performance (42 Lamp. à 80 - 200 W) incl. AC PLUS • incl. Aqua Fresh & Aroma • incl. NFC	500001148	26,195.-



* Watt Input (Output)

Optional extra: 3D-Sound-Unit**	100003217	1,035.-
---------------------------------	-----------	---------

Featured as standard

DYNAMIC 42x 200 W PERFORMANCE	SMART TWIN POWER 26x 160 W 16x 140 W PERFORMANCE	ULTRA 4 x 400 W 3x 8 W PERFORMANCE +	LED LIGHT SHOW	INTERIOR LIGHT	BODYFORM PLUS 225 x 82 CM
COMFORT COOLING +	AIR CONDITION +	AQUA FRESH	AROMA	NFC CONNECT	

Optional at extra costs

3D SOUND	MP3 AUX
VOICE GUIDE	

Lamps: 26 top part (1,80 m)/16 base part (2,00 m)

** 3D-Sound unit includes Voice Guide, MP3- & iPod-Dock-in, SD-Card-Slot Automatic Volume and Auto Play.

ERGO LINE INSPIRATION 500 SLP

HYBRID PERFORMANCE



FEATURED AS STANDARD

- Hybrid Performance
- Smart Light Performance
- LED Mood Light
- Interior Light
- Bodyform PLUS
- Comfort Cooling PLUS

DIMENSIONS (in mm)

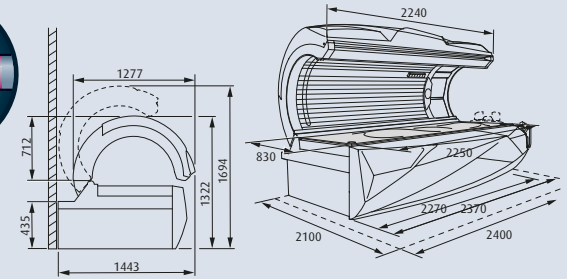

LAMPS	FT	WATTS MAX.	FT SPAGHETTIS
38	3	400	2 x 8 W

DESIGN BRILLIANT WHITE

Art. No. EN

Euro, excl. VAT.

Featured as standard Hybrid Performance, Twin Power [24 Lamps à 140 (160) W/14 Lamps à 120 (140) W]*, static electronic ballasts

100003447



18,775.-

* Watt Input (Output)

Optional extra: 3D-Sound-Unit**

100003217

1,035.-

Featured as standard

<p>HYBRID</p> <p>12x 160/140 W</p> <p>26x 160/140 W</p> <p>PERFORMANCE</p>	<p>SMART LIGHT</p> <p>PERFORMANCE</p>	<p>LED MOOD LIGHT</p>	<p>INTERIOR LIGHT</p>
<p>225 x 82 CM</p> <p>BODYFORM PLUS</p>	<p>COMFORT COOLING +</p>		

Lamps: 24 top part (1,80 m)/14 base part (2,00 m)

Optional at extra costs

<p>3D SOUND</p>	<p>MP3 AUX</p>
<p>VOICE GUIDE</p>	

ERGOLINE INSPIRATION 500 SMART PERFORMANCE



FEATURED AS STANDARD

- Ultra Performance PLUS
- LED Light Show
- Interior Light
- Bodyform PLUS
- Comfort Cooling PLUS

Optional (only Turbo Power)

- Air Condition PLUS



DIMENSIONS (in mm)

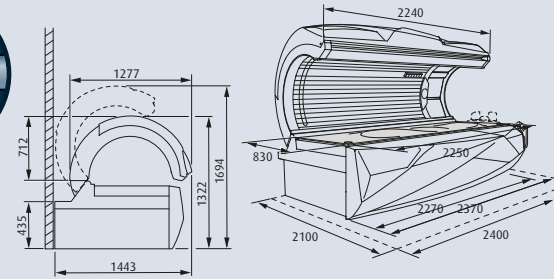

LAMPS	FT	WATTS MAX.	FT SPAGHETTIS
38	3	400	2 x 8 W

DESIGN SATIN SILVER

	Art. No. EN		Euro, excl. VAT.
Featured as standard Smart Performance, Super Power [24 Lamps à 100 (120) W/14 Lamps à 120 (140) W]*	100003154	TOP SELLER	16,695.-
Featured as standard Smart Performance, Twin Power [24 Lamps à 140 (160) W/14 Lamps à 120 (140) W]*	100003166		18,275.-
Featured as standard Smart Performance, Turbo Power [38 Lamps à 140 (160 W)]* incl. Air Condition PLUS	100003198	TOP SELLER	20,195.-
Optional extra: 3D-Sound-Unit**	100003217		1,035.-

Featured as standard

SMART
TURBO POWER
24x 160 W
14x 180 W
PERFORMANCE

SMART
TWIN POWER
24x 160 W
14x 140 W
PERFORMANCE

SMART
SUPER POWER
24x 120 W
14x 140 W
PERFORMANCE

ULTRA
3 x 400 W
2 x 8 W
PERFORMANCE +

LED LIGHT SHOW

INTERIOR LIGHT

BODYFORM PLUS
225 x 82 CM

COMFORT COOLING +

AIR CONDITION +

Optional at extra costs

3D SOUND

MP3 AUX

VOICE GUIDE

Lamps: 24 top part (1,80 m)/14 base part (2,00 m)

** 3D-Sound unit includes Voice Guide, MP3- & iPod-Dock-in, SD-Card-Slot Automatic Volume and Auto Play.

ERGO LINE INSPIRATION 400 ADVANCED PERFORMANCE



FEATURED AS STANDARD

- Advanced Performance
- Ultra Performance PLUS
- Interior Light
- Bodyform PLUS
- Comfort Cooling
- Mood Light



DIMENSIONS (in mm)

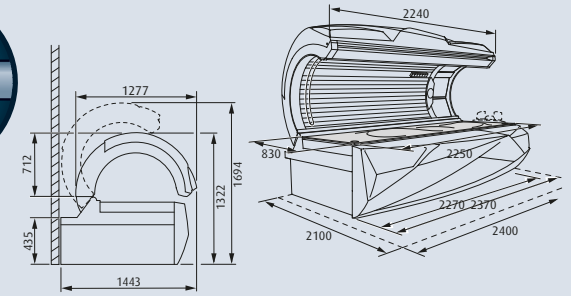

LAMPS	FT	WATTS	FT SPAGHETTIS
38	3	400	2x 8 W

DESIGN BRILLIANT WHITE

Art. No. EN

Euro, excl. VAT

SFeatured as standard Advanced Performance, Super Power [24 Lamps à 100 W/14 Lamps à 120 W]*

100003327

14,695.-

Optional extra: 3D-Sound-Unit**

100001531

1,035.-

Add-on kit Inspiration: Intermediate acrylic without fan

100001854

355.-

Featured as standard

ADVANCED SUPER POWER 24x 100 W 14x 120 W PERFORMANCE	ULTRA 3 x 400 W 2 x 8 W PERFORMANCE +	INTERIOR LIGHT
225 x 82 CM BODYFORM PLUS	COMFORT COOLING	MOOD LIGHT

Lamps: 24 top part (1,80 m)/14 base part (2,00 m)

Optional at extra costs

3D SOUND	MP3 AUX
VOICE GUIDE	

ERGOLINE PASSION 300-S
ERGOLINE PASSION 350-S



DIMENSIONS (in mm)

- Ultra Performance PLUS
- Mood Light Techno Yellow (Passion 300-S)
- Photo Art People Single (Passion 350-S)
- Bodyform PLUS
- Comfort Cooling
- Time Control



DIMENSIONS (in mm)

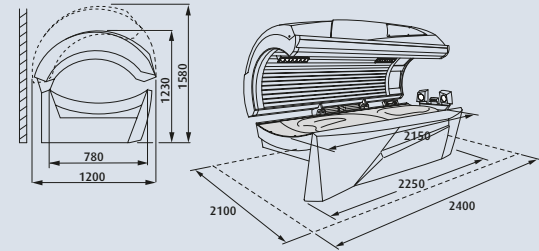

FT WATTS MAX. FT SPAGHETTIS

3 **400** **2 x 8 W**

DESIGN BRILLIANT WHITE

	Art. No. EN	Euro, excl. VAT
Featured as standard 300-S Super Power Mood Light Techno Yellow (34 Lamps à 100 W)	500000760	9,395.-
Featured as standard 300-S Twin Power Mood Light Techno Yellow (18 Lamps à 140 W/16 Lamps à 100 W)	500000764	9,995.-
Featured as standard 350-S Super Power Photo Art People Single (38 Lamps à 100 W)	500000769	10,995.-
Featured as standard 350-S Turbo Power Photo Art People Single (38 Lamps à 140 W)	500000777	12,095.-
Optional extra: Stereo Sound	100002315	365.-
Optional extra: Stereo Sound PLUS*	100002312	730.-
Optional extra: Side cover Passion (one-piece)	100002314	105.-



Featured as standard

SUPER 34x 100 W POWER	TWIN 18x 140 W 16x 100 W POWER	SUPER 38x 100 W POWER	TURBO 38 x 140 W POWER	ULTRA 3x 400W 2x 8 W PERFORMANCE+
MOOD LIGHT	PHOTO ART	BODYFORM PLUS 215 x 78 CM	COMFORT COOLING	TIME CONTROL 12:00

Optional at extra costs

STEREO SOUND	STEREO SOUND +
---------------------	-----------------------

Lamps Ergoline Passion 300-S: 18 top part (1,80 m)/16 base part (2,00 m) | Lamps Ergoline Passion 350-S: 22 top part (1,80 m)/16 base part (2,00 m)

* Stereo Sound PLUS includes external audio connection, amplifier, headset and MP3-connect and Auto Play.

ERGO LINE FLAIR 250 SUPER POWER

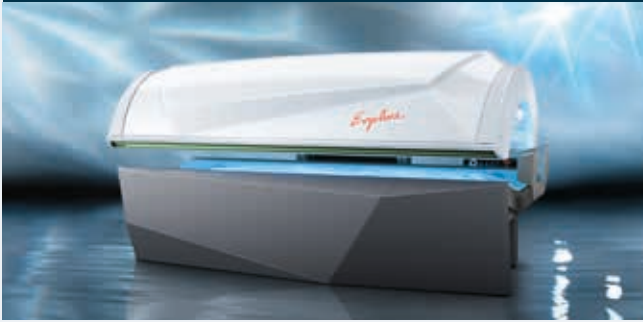

FEATURED AS STANDARD

- Super Power
- Ultra Performance
- Bodyform PLUS
- Comfort Cooling
- Time Control

LAMPS	WATTS	FT	WATTS
30	100	3	400

DIMENSIONS (in mm)

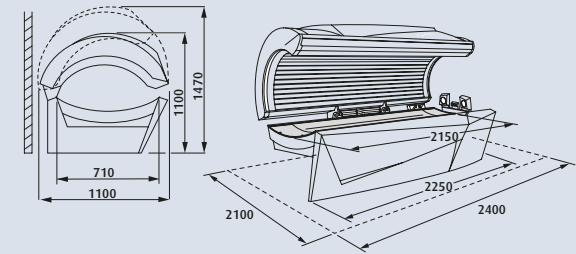

DESIGN BRILLIANT WHITE ANTHRACITE

Featured as standard incl. PROFILE-Design Shining Green

Art. No. EN

100002070



Euro, excl. VAT

7,695.-

Optional extra: PROFILE-Design Anthracite

100002370

75.-

Optional extra: Stereo Sound

100002315

365.-

Optional extra: Stereo Sound PLUS*

100002312

730.-

Optional extra: Side cover Passion (one-piece)

100002313

105.-

Featured as standard

<p>SUPER</p> <p>POWER</p>	<p>ULTRA</p> <p>PERFORMANCE</p>	<p>215 x 71 CM</p> <p>BODYFORM PLUS</p>
<p>COMFORT COOLING</p>	<p>TIME CONTROL</p>	

Lamps: 18 top part (1,80 m)/12 base part (2,00 m)

Optional at extra costs

<p>STEREO SOUND</p>	<p>STEREO SOUND +</p>
---------------------	-----------------------

* Stereo Sound PLUS includes external audio connection, amplifier, headset and MP3-connect and Auto Play.

ERGOLINE FLAIR 200 SUPER POWER



FEATURED AS STANDARD

- Super Power
- Ultra Performance
- Bodyform PLUS
- Comfort Cooling
- Time Control
- 230 V connection

LAMPS	WATTS	FT	WATTS
27	100	1	300

DIMENSIONS (in mm)

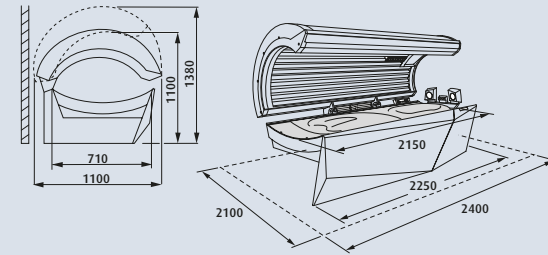

DESIGN SOFT GREY SILVER

Featured as standard incl. PROFILE-Design Anthracite

Art. No. EN

100001899



Euro, excl. VAT

6,195.-

Optional extra: PROFILE-Design Shining Green

100002369

75.-

Optional extra: Stereo Sound

100002315

365.-

Optional extra: Stereo Sound PLUS*

100002312

730.-

Optional extra: Side cover Passion (one-piece)

100002313

105.-

Featured as standard

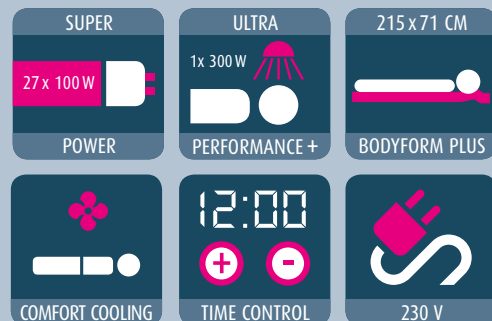

Optional at extra costs



Lamps: 16 top part (1,80 m)/11 base part (1,80 m)

* Stereo Sound PLUS includes external audio connection, amplifier, headset and MP3-connect and Auto Play.

ERGO LINE SUNRISE 480 ADVANCED PERFORMANCE



FEATURED AS STANDARD

- Advanced Performance (Turbo Power)
- Interior Light
- Silent Cooling
- Body Space

LAMPS WATTS MAX.

48

180

DIMENSIONS (in mm)

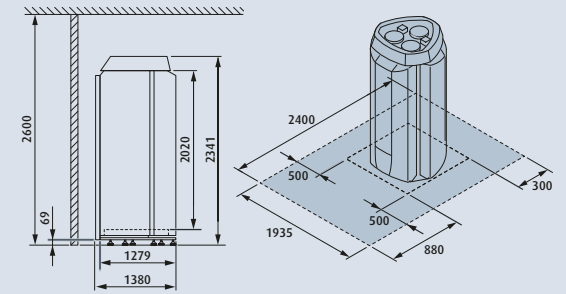

DESIGN BRIGHT WHITE

	Art. No. EN	Euro, excl. VAT.
Featured as standard Sunrise 480 Advanced Performance (Turbo Power)	500000451	14,195.-
Optional extra: Aqua Fresh & Aroma	500000463	2,145.-
Optional extra: 3D-Sound-Unit*	100001841	1,035.-
Optional extra: Vibra Shape	100001843	4,595.-

Please note: An adaptor is necessary to connect MCS controls - see page 35!

Featured as standard



Optional at extra costs



ERGOLINE SUNRISE 488 DYNAMIC PERFORMANCE



FEATURED AS STANDARD

- Dynamic Performance
- Interior Light
- Silent Cooling
- Body Space

LAMPS WATTS MAX.

48	200
-----------	------------

DIMENSIONS (in mm)

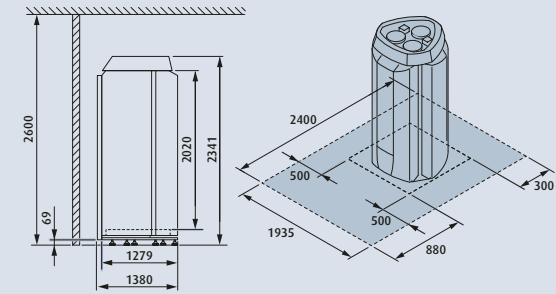

DESIGN BRIGHT WHITE

	Art. No. EN		Euro, excl. VAT.
Featured as standard Sunrise 488 Dynamic Performance	500000403	TOP SELLER	16,395.-
Optional extra: Aqua Fresh & Aroma	500000463		2,145.-
Optional extra: 3D-Sound-Unit*	100001841		1,035.-
Optional extra: Vibra Shape	100001843		4,595.-

Please note: An adaptor is necessary to connect MCS controls - see page 35!

Featured as standard

<p>DYNAMIC 48 x 200 W PERFORMANCE</p>	<p>INTERIOR LIGHT</p>	<p>SILENT COOLING</p>	<p>BODY SPACE</p>
---	------------------------------	------------------------------	--------------------------

Optional at extra costs

<p>AQUA FRESH</p>	<p>AROMA</p>	<p>3D SOUND</p>
<p>MP3 AUX</p>	<p>VOICE GUIDE</p>	<p>VIBRA SHAPE</p>

* 3D-Sound unit includes Voice Guide, MP3- & iPod-Dock-in, SD-Card-Slot Automatic Volume and Auto Play.

ERGO LINE ESSENCE 440

SMART POWER



FEATURED AS STANDARD

- Smart Power
- Top Cooling
- Body Space
- Single Sound
- Time Control

LAMPS WATTS INPUT (OUTPUT)

44 (2m)

180 (200)

DIMENSIONS (in mm)

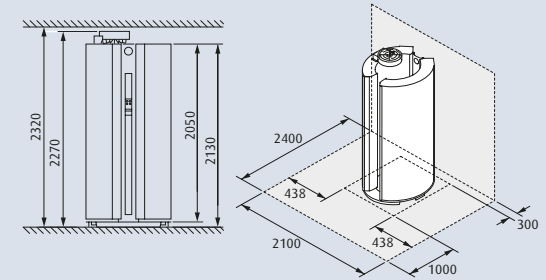

Featured as standard Scarlet Red incl. Standby Lighting

Art. No. EN

100002594



Euro, excl. VAT.

10,275.-

Optional extra: Sound Module*

100002544

410.-

Optional extra: Aroma

100002619

105.-

Optional extra: Connecting wiring 3 x 230V without neutral wire**

1508181-00

55.-

Featured as standard

Optional at extra costs

* Sound Module includes amplifier, headset, Smartphone & MP3-connection and Auto Play.
 ** Necessary for connection of this unit in the following countries: Colombia, Mexico, Japan, Korea, Israel partially, Uruguay, Venezuela, Norway, Brazil, Ecuador, Dominican Republic, El Salvador, Guatemala, Honduras, Nicaragua, Panama, Peru, Philippines, Saudi Arabia, Taiwan, Tunisia partially, Belgium partially.

ERGO LINE BALANCE 700
ERGO LINE BALANCE 770



FEATURED AS STANDARD

- Hybrid Performance
- Electronic ballasts
- Beauty Select (Balance 770)
- LED Light Show
- Interior Light
- Smart Control
- Frosted Acrylic
- Comfort Cooling PLUS
- Climatronic (Balance 770)

DIMENSIONS (in mm)

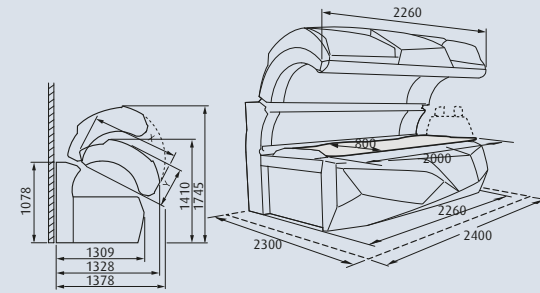

UV	WATTS	BEAUTY LIGHT	WATTS
32	180/160	14	180/160

DESIGN BRILLIANT WHITE

Featured as standard Balance 700

Featured as standard Balance 770 incl. Climatronic

Art. No. EN

Euro, excl. VAT.

**INCLUDING
2 ADDITIONAL
SETS OF LAMPS***

**TOP
SELLER**

100003275

100003274

22,995.-

26,575.-

Optional extra: 3D-Sound-Unit**

100003074

1,035.-

Featured as standard

HYBRID 32 x 180/160 W 14 x 180/160 W PERFORMANCE	PURE BEAUTY BEAUTY & SUN SUN & BEAUTY BEAUTY SELECT	LED LIGHT SHOW	INTERIOR LIGHT
SMART CONTROL	200 x 80 CM FROSTED ACRYLIC	COMFORT COOLING +	CLIMATRONIC

Optional at extra costs

3D SOUND	MP3 AUX	VOICE GUIDE
-----------------	----------------	--------------------

UV lamps: 20 top part/side part (180 W - 2,00m)
12 base part (160 W - 1,80m)

Beauty Light: 8 top part/side part (180 W - 2,00m)
6 base part (160 W - 1,80m)

* You receive two additional sets of lamps with UV lamps and Beauty Light lamps.

** 3D-Sound unit includes Voice Guide, MP3- & iPod-Dock-in, SD-Card-Slot Automatic Volume and Auto Play.

SUN ANGEL DUO 1400 INDIVIDUAL PERFORMANCE

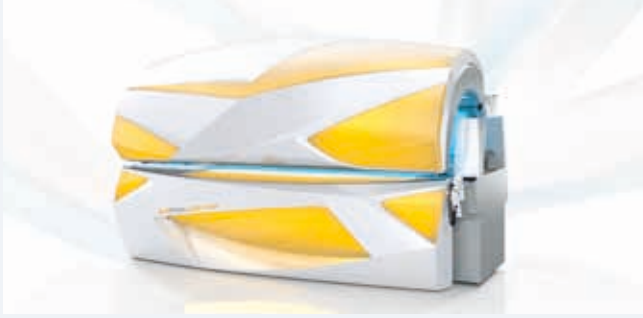

FEATURED AS STANDARD

- Sensor
- Duo Select
- Individual Performance
- Ultra Performance PLUS
- Shoulder Tan
- LED Light Show
- Interior Light
- Multi Relax
- Comfort Cooling
- Climatronic
- Aqua Fresh
- Aroma
- NFC Connect
- Control Center
- 3D-Sound-Unit
- Bluetooth

LAMPS	WATTS MAX.	FT	WATTS MAX.	FT SPAGHETTIS
52	200	4	520	3 x 8 W

DIMENSIONS (in mm)

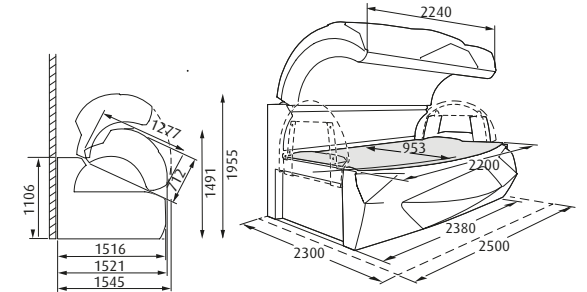

DESIGN HEAVENLY WHITE

Art. No. EN

Euro, excl. VAT.

Featured as standard incl. Climatronic

50001298

45,095.-

Featured as standard



Lamps: 24 top part/8 side part/20 base part | The power of the facials might be reduced to 420 W due to national regulations (0.3 W/m²).

* 3D-Sound unit includes Voice Guide, MP3- & iPod-Dock-in, SD-Card-Slot Automatic Volume and Auto Play.

BEAUTY ANGEL C 28

FEATURED AS STANDARD

- Beauty Light
- Beauty Design
- Body Form Plus
- Comfort Cooling
- 230 connection
- Time Control

LAMPS

28

WATTS INPUT (OUTPUT)

100

DIMENSIONS (in mm)

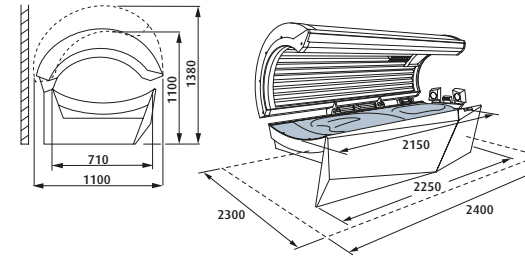

DESIGN BRILLIANT WHITE

Art. No. EN

Euro, excl. VAT.

Featured as standard [28 lamps à 100 W]

100002455

7,895.-

Optional extra: Stereo Sound

100002315

365.-

Optional extra: Stereo Sound Plus*

100002312

730.-

Optional extra: Side cover

100002313

105.-

Featured as standard



Optional at extra costs

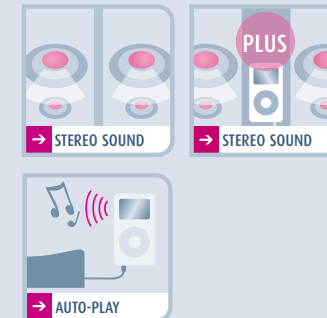

* Stereo Sound Plus includes external audio connection, amplifier, headset and MP3-connect and Auto Play.

BEAUTY ANGEL CVT 32



FEATURED AS STANDARD

- Beauty Light
- Beauty Design
- Standby Lighting
- Body Space
- Single Sound
- Time Control
- Vibra Shape

LAMPS WATTS INPUT (OUTPUT)

32 (2m)

200

DIMENSIONS (in mm)

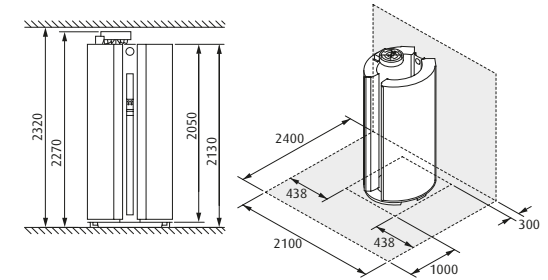

DESIGN BRILLIANT WHITE

Art. No. EN

Euro, excl. VAT.

Featured as standard [32 lamps à 200 W]

500001090

15,575.-

Optional extra: Top Cooling

100002543

410.-

Optional extra: Aroma

100002642

105.-

Optional extra: Sound Module*

100002544

410.-

Optional extra: Connecting wiring 3 x 230V without neutral wire**

1508181-00

55.-

Featured as standard



Optional at extra costs

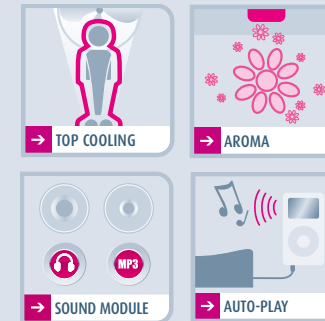

PROFESSIONAL SUNBEDS
HYBRID UNITS
BEAUTY ANGEL

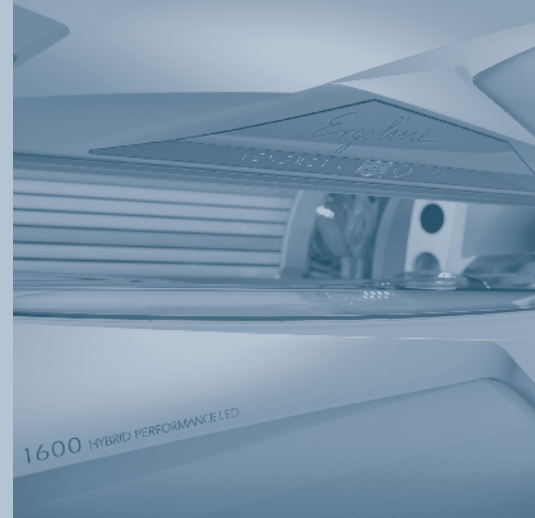

PROFESSIONAL SUNBEDS | HYBRID-UNITS

AIR DISCHARGE SYSTEMS
ACCESSORIES



AIR DISCHARGE SYSTEMS | ACCESSORIES

CONTROL SYSTEMS
STUDIO EQUIPMENT



CONTROL SYSTEMS | STUDIO EQUIPMENT

ERGOLINE PRESTIGE
SUN ANGEL DUO 1400

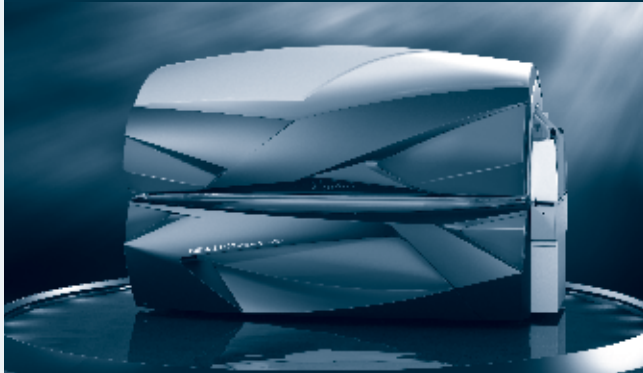

DIMENSIONS ERGOLINE PRESTIGE (in mm)

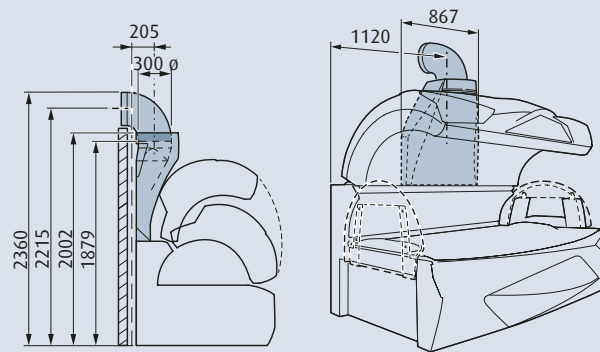

	Art. No. with warm air recovery	Euro, excl. VAT	Art. No. without warm air recovery	Euro, excl. VAT.
Central air discharge socket in Brilliant Silver with direct connection possibility (300 mm Ø) upwards. Channelling the air to the right, to the left or to the rear requires additional use of the curved profile (Art. No. 100001292).	500000872	815.-	500000873	670.-
90° curved profile in Brilliant Silver for routing the air discharge hose to the right, left or rear, including pipe adapter for direct connection to the central air discharge socket. Air ducting possible via direct 300 mm Ø air discharge hose connection.	100001292	165.-	100001292	165.-
Connection socket for 300 mm Ø air discharge hose	34503600	20.-	34503600	20.-
Air discharge hose 300 mm Ø, flexible, grey, 6 m, with 2 hose clips	34502800	110.-	34502800	110.-
Air discharge hose connector 300 mm Ø	34502700	27.-	34502700	27.-
Air discharge assembly for connecting to double rear pane	34526600	85.-	34526600	85.-

ERGOLINE AFFINITY
ERGOLINE BALANCE

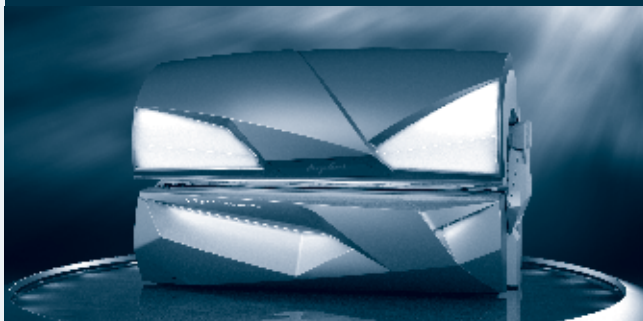

DIMENSIONS ERGOLINE AFFINITY/BALANCE (in mm)

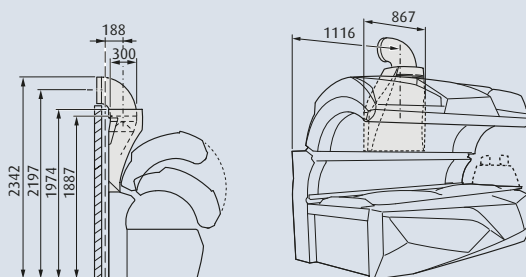

Art. No. with warm air recovery	Euro, excl. VAT	Art. No. without warm air recovery	Euro, excl. VAT.
50000872	815.-	50000873	670.-
100001292	165.-	100001292	165.-
34503600	20.-	34503600	20.-
34502800	110.-	34502800	110.-
34502700	27.-	34502700	27.-
34526600	85.-	34526600	85.-
1016325-00	615,-	1016325-00	615,-

Central air discharge socket in Brilliant Silver with direct connection possibility (300 mm Ø) upwards. Channelling the air to the right, to the left or to the rear requires additional use of the curved profile (Art. No. 100001292).

90° curved profile in Brilliant Silver for routing the air discharge hose to the right, left or rear, including pipe adapter for direct connection to the central air discharge socket. Air ducting possible via direct 300 mm Ø air discharge hose connection.

Connection socket for 300 mm Ø air discharge hose

Air discharge hose 300 mm Ø, flexible, grey, 6 m, with 2 hose clips

Air discharge hose connector 300 mm Ø

Air discharge assembly for connecting to double rear panel

Add-on kit intermediate acrylic and fan for Affinity 700 Twin Power

AUDIO (for Affinity, Balance, Esprit, Prestige, Inspiration)

Wire set audio
(incl. channel selection)

Wire audio
(without channel selection)

Prod. ref. no.	Euro, excl. VAT	Prod. ref. no.	Euro, excl. VAT
500000160	40.-	500000161	25.-

ERGO LINE INSPIRATION

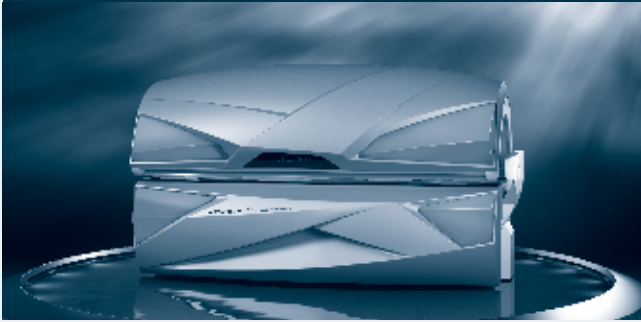

DIMENSIONS ERGO LINE INSPIRATION (in mm)

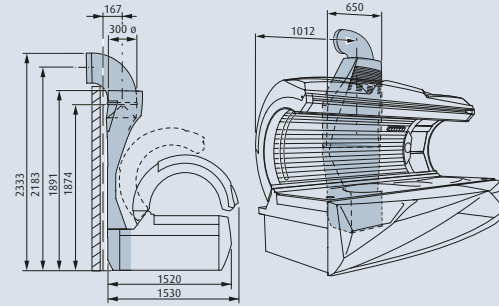

Central air discharge socket in Brilliant Silver with direct connection possibility (300 mm Ø) upwards. Channelling the air to the right, to the left or to the rear requires additional use of the curved profile (Art. No. 100001292).

90° curved profile in Brilliant Silver for routing the air discharge hose to the right, left or rear, including pipe adapter for direct connection to the central air discharge socket. Air ducting possible via direct 300 mm Ø air discharge hose connection.

Connection socket for 300 mm Ø air discharge hose

Air discharge hose 300 mm Ø, flexible, grey, 6 m, with 2 hose clips

Air discharge hose connector 300 mm Ø

Art. No. with warm air recovery	Euro, excl. VAT	Art. No. without warm air recovery	Euro, excl. VAT
50000892	815.-	50000893	670.-
100001292	165.-	100001292	165.-
34503600	20.-	34503600	20.-
34502800	110.-	34502800	110.-
34502700	27.-	34502700	27.-

ERGOLINE PASSION 300/350



DIMENSIONS ERGOLINE PASSION (IN MM)

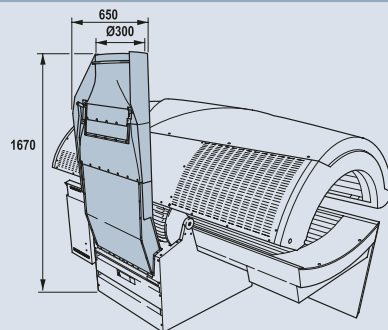

ERGOLINE AIR DISCHARGE SYSTEM PASSION 300/350

Art. No. with warm air recovery (manual)	Euro, excl. VAT	Art. No. without warm air recovery	Euro, excl. VAT
500000870	770.-	500000871	670.-
100001292	165.-	100001292	165.-
34503600	20.-	34503600	20.-
34502800	110.-	34502800	110.-
34502700	27.-	34502700	27.-

Central air discharge socket in Brilliant Silver with direct connection possibility (300 mm Ø) upwards. Channelling the air to the right, to the left or to the rear requires additional use of the curved profile (Art. No. 100001292).

90° curved profile in Brilliant Silver for routing the air discharge hose to the right, left or rear, including pipe adapter for direct connection to the central air discharge socket. Air ducting possible via direct 300 mm Ø air discharge hose connection.

Connection socket for 300 mm Ø air discharge hose

Air discharge hose 300 mm Ø, flexible, grey, 6 m, with 2 hose clips

Air discharge hose connector 300 mm Ø

**ERGO LINE ESSENCE 440
BEAUTY ANGEL CVT 32**



ERGO LINE AIR DISCHARGE SYSTEM ESSENCE 440 / CVT 32

	Art. No.	Euro, excl. VAT without warm air recovery
Central air discharge socket in Brilliant Silver with integrated air discharge motor	100002542	670.-
Connection socket for 150 mm Ø air discharge hose	500000942	40.-
Air discharge hose , Ø 150 mm, flexible, grey, 6 m, with 2 hose clips	500000940	95.-
Adapter , from Ø 150 mm to Ø 300 mm	500000941	40.-

ERGO LINE SUNRISE



ERGO LINE AIR DISCHARGE SYSTEM SUNRISE

	Art. No.	Euro, excl. VAT without warm air recovery
Air discharge box*	100001962	1,120.-
90° curved profile in Brilliant Silver	100001292	165.-
Air discharge hose 300 mm Ø, flexible, grey, 6 m, with 2 hose clips	34502800	110.-
Air discharge hose connector Ø 300 mm	34503600	20.-

DIMENSIONS AIR DISCHARGE BOX (IN MM)

Technical Data:

Total power consumption:
ca. 1,200 W
Line voltage: 230-240 V~3
Rated frequency: 50 Hz
Fuses (slow-blowing): ca. 1x16 A
Air consumption max.:
ca. 2,600 m³/h
(ambient temperature 25°C
and air in max. 40°C)

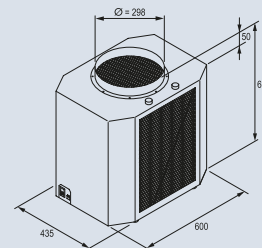

DIMENSIONS ERGO LINE SUNRISE, ESSENCE, CVT 32 (IN MM)

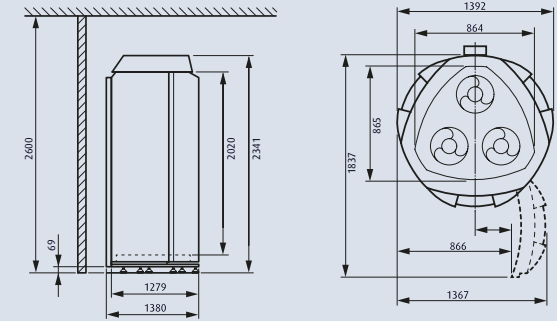

* Can be used for all sunbeds

PROFESSIONAL SUNBEDS
HYBRID UNITS
BEAUTY ANGEL

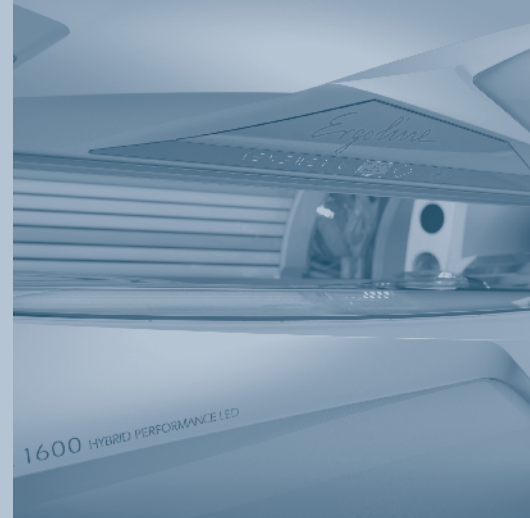

PROFESSIONAL SUNBEDS | HYBRID-UNITS

AIR DISCHARGE SYSTEMS
ACCESSORIES



AIR DISCHARGE SYSTEMS | ACCESSORIES

CONTROL SYSTEMS
STUDIO EQUIPMENT



CONTROL SYSTEMS | STUDIO EQUIPMENT

ERGOLINE CONTROL SYSTEMS

ERGOLINE STUDIO PILOT

	Art. No.	Euro, excl. VAT
Studio Pilot¹: Central control unit for operating up to 25 sunbeds	34009900	2,490.-
Sunbed interface 1: Control module for each sunbed (also other producers)	34523700	335.-
TV interface: Control module for monitor or television (display of cabin booking)	34523800	835.-

¹ Only available in German-speaking countries and only available in German language

To operate the Studio-Manager Software the following requirements must be fulfilled:

- Computer interface is available according to Ergoline specifications
- Bus line to PC is laid and functional
- Power connection for computer (is connected to the computer) is laid and functional
- Internet-connection is available and functional

* Only possible with Studio-Manager and graphics card with 2 monitor outputs

** The Studio-Manager Version 2 is only to be operated with the Studio-Manager accessories listed by Ergoline!

ERGO LINE MANUAL REMOTE CONTROL SYSTEM

incl. 5 m control cable and plug (extra-low voltage), with master card and double shut-down safety facility according to EN 60335-2-27/A11:2002

	Art. No.	Euro, excl. VAT
Mikrocomputer MCS III plus	500000456	405.-
Adapter for connecting MCS controls (for Sunrise)	100001853	230,-

NFC-CARDS / NFC-TAGS

	Artikel-Nr.	Euro ohne MwSt.
Package NFC-Cards Prestige consisting of: 2 pcs. Professional Set-up Card, 2 pcs. LED Light Show, 2 pcs. ECO Tech	500001175	33.-
Package NFC-Cards Inspiration 600 consisting of: 2 pcs. Professional Set-up Card, 2 pcs. LED Light Show	500001178	22.-
Personal Comfort Card with 4-colour printing , 100 per unit	1014733-00	210.-
NFC-Tags with 4-colour printing , 100 per unit	1014735-00	160.-

ACCESSORIES FOR STUDIO-PILOT/STUDIO-MANAGER

For all Ergoline professional sunbeds

	Art. No.	Euro, excl. VAT
Brass tokens for Ergoline token box and Studio Pilot, 50 per unit	34005300	30.-
Chip cards with 4-colour printing for MCS VI, Studio Pilot and Studio-Manager, 100 per unit	34009500	312.-
Chip cards with 4-colour printing for MCS VI, Studio Pilot and Studio-Manager, 400 per unit	34524700	1.085.-
Chip card plain for MCS VI, Studio Pilot and Studio-Manager, 100 per unit	38000500	270.-
Salon card (personnel card) for MCS VI, Studio Pilot and Studio-Manager with 4-colour printing	34010100	13.-
Control cable Studio Pilot for multi-tasker bus (100 m run)	34510400	105.-
Document verification for MCS-token boxes and Studio Pilot	500000880	570.-
Computer-Interface for PC connection to control line	34590200	440.-

STUDIO EQUIPMENT

	Art. No.	Euro, excl. VAT
Ergoline LED Display Format (in mm): 900 x 400 x 37	100003454	310,-



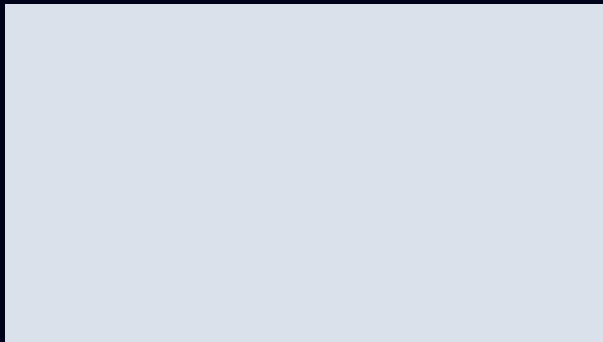



JK-INTERNATIONAL GMBH · Koehlershohner Strasse · 53578 Windhagen · Germany

 +49 2224/818-0  www.en.ergoline.de  info@ergoline.de

 www.facebook.com/ErgolineWorld

 [instagram.com/ErgolineWorld](https://www.instagram.com/ErgolineWorld)

 [youtube.com/ErgolineWorld](https://www.youtube.com/ErgolineWorld)

Ergoline